

Kit 1109

- NISSAN Mistral**, 3-dr SUV, 93-06
- NISSAN Mistral**, 5-dr SUV, 93-06
- NISSAN Terrano II**, 3-dr SUV, 93-02, 03-
- NISSAN Terrano II**, 5-dr SUV, 93-02, 03-
- FORD Maverick**, 3-dr SUV, 93-99
- FORD Maverick**, 5-dr SUV, 93-99
- KIA Sportage**, 3-dr SUV, 96-03 / *96-02
- KIA Sportage**, 5-dr SUV, 94-03, 04- / *95-02

*North America

480R
754

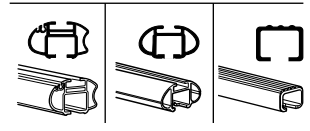
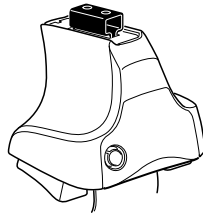

480

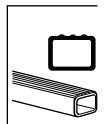
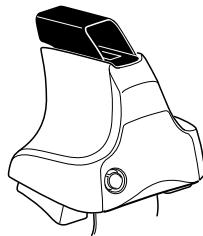

750

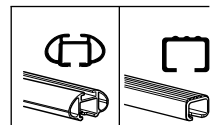
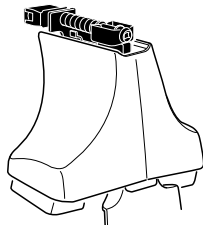

THULE[®]
SWEDEN

ISO 11154-E

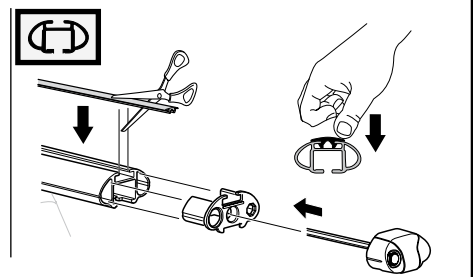
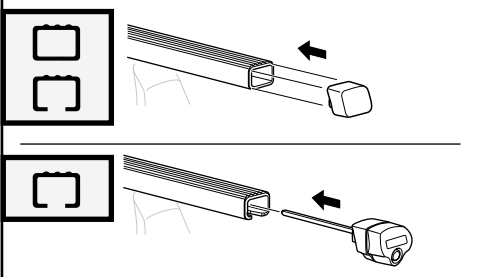
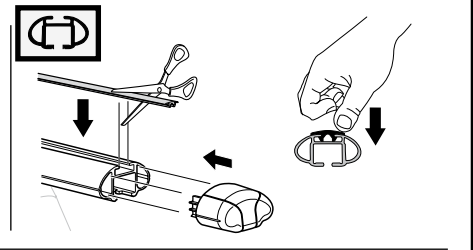
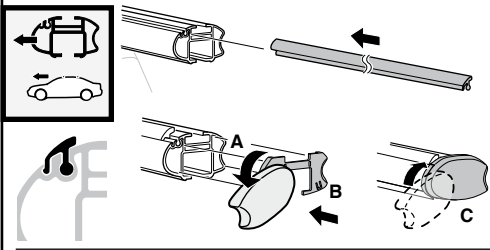
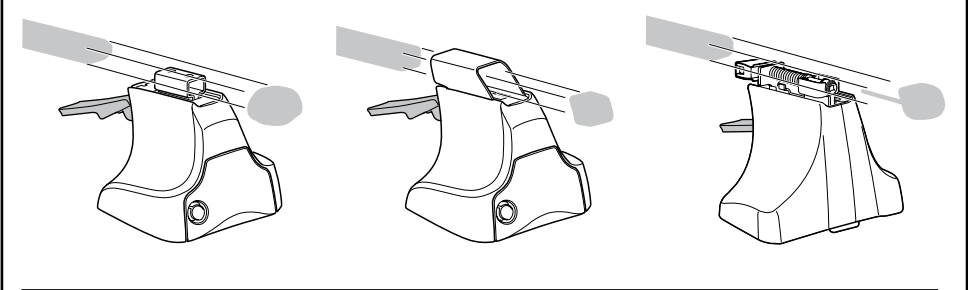
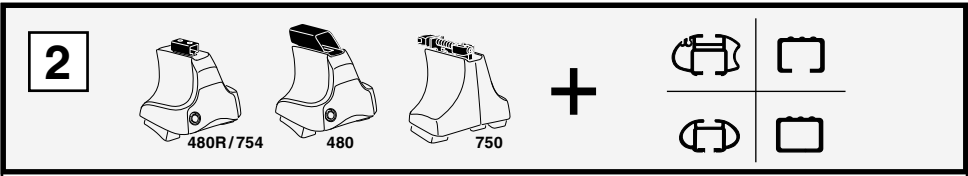
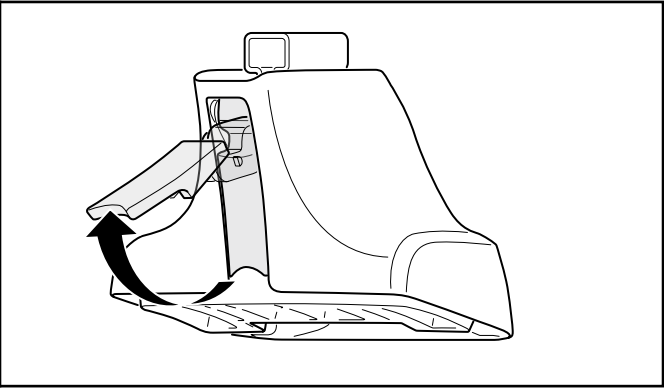
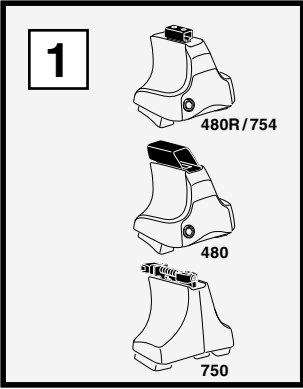

3

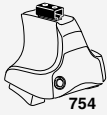

754

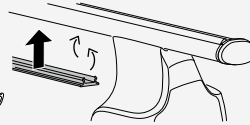
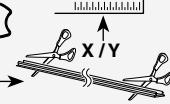

750

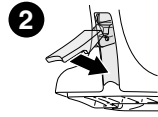
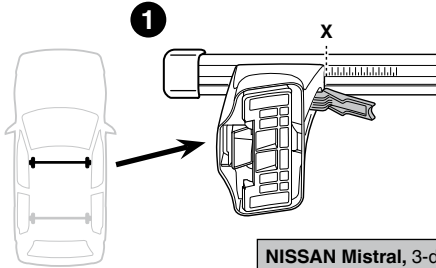

	X
NISSAN Mistral , 3-dr SUV, 93-06	33,5
NISSAN Mistral , 5-dr SUV, 93-06	33,5
NISSAN Terrano II , 3-dr SUV, 93-02, 03-	33,5
NISSAN Terrano II , 5-dr SUV, 93-02, 03-	33,5
FORD Maverick , 3-dr SUV, 93-99	33,5
FORD Maverick , 5-dr SUV, 93-99	33,5
KIA Sportage , 3-dr SUV, 96-03 / *96-02	31
KIA Sportage , 5-dr SUV, 94-03, 04- / *95-02	31

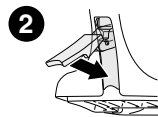
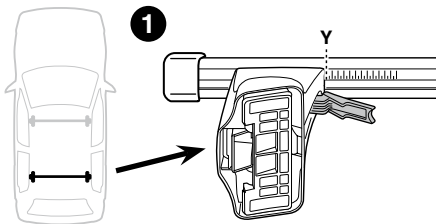

	Y
NISSAN Mistral , 3-dr SUV, 93-06	33,5
NISSAN Mistral , 5-dr SUV, 93-06	32
NISSAN Terrano II , 3-dr SUV, 93-02, 03-	33,5
NISSAN Terrano II , 5-dr SUV, 93-02, 03-	32
FORD Maverick , 3-dr SUV, 93-99	33,5
FORD Maverick , 5-dr SUV, 93-99	32
KIA Sportage , 3-dr SUV, 96-03 / *96-02	28,5
KIA Sportage , 5-dr SUV, 94-03, 04- / *95-02	28,5

3



480R



480

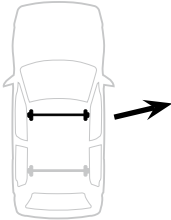
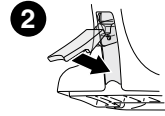
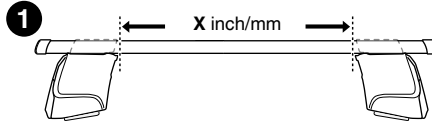

	X inch	X mm
NISSAN Mistral, 3-dr SUV, 93-06	38 $\frac{7}{8}$"	986
NISSAN Mistral, 5-dr SUV, 93-06	38 $\frac{7}{8}$"	986
NISSAN Terrano II, 3-dr SUV, 93-02, 03-	38 $\frac{7}{8}$"	986
NISSAN Terrano II, 5-dr SUV, 93-02, 03-	38 $\frac{7}{8}$"	986
FORD Maverick, 3-dr SUV, 93-99	38 $\frac{7}{8}$"	986
FORD Maverick, 5-dr SUV, 93-99	38 $\frac{7}{8}$"	986
KIA Sportage, 3-dr SUV, 96-03 / *96-02	37 $\frac{7}{8}$"	961
KIA Sportage, 5-dr SUV, 94-03, 04- / *95-02	37 $\frac{7}{8}$"	961

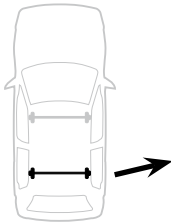
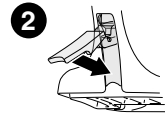
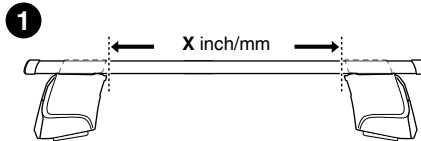

	X inch	X mm
NISSAN Mistral, 3-dr SUV, 93-06	38 $\frac{7}{8}$"	986
NISSAN Mistral, 5-dr SUV, 93-06	38 $\frac{1}{4}$"	971
NISSAN Terrano II, 3-dr SUV, 93-02, 03-	38 $\frac{7}{8}$"	986
NISSAN Terrano II, 5-dr SUV, 93-02, 03-	38 $\frac{1}{4}$"	971
FORD Maverick, 3-dr SUV, 93-99	38 $\frac{7}{8}$"	986
FORD Maverick, 5-dr SUV, 93-99	38 $\frac{1}{4}$"	971
KIA Sportage, 3-dr SUV, 96-03 / *96-02	36 $\frac{7}{8}$"	936
KIA Sportage, 5-dr SUV, 94-03, 04- / *95-02	36 $\frac{7}{8}$"	936

4

NISSAN Mistral, 3-dr SUV, 93-06

NISSAN Terrano II, 3-dr SUV, 93-02, 03-

FORD Maverick, 3-dr SUV, 93-99

KIA Sportage, 3-dr SUV, 96-03 / *96-02

SRA

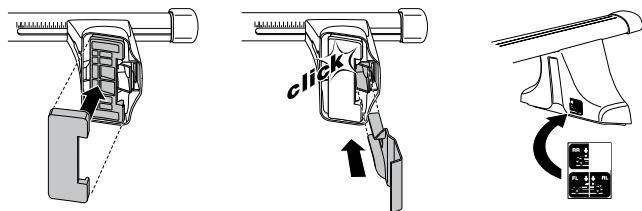
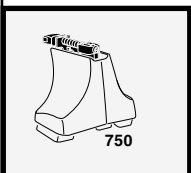
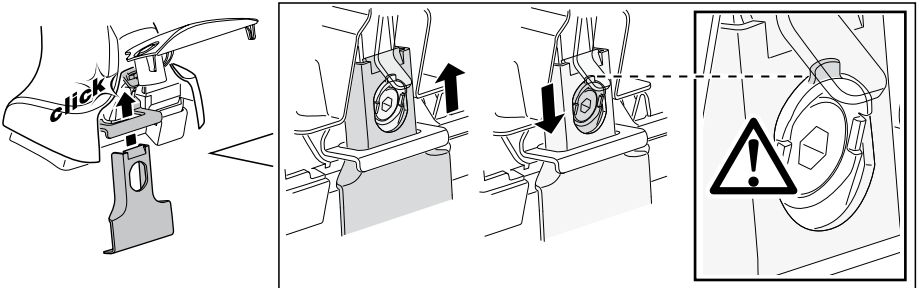
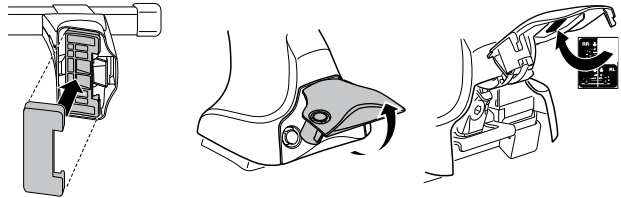
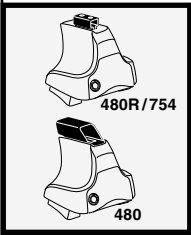
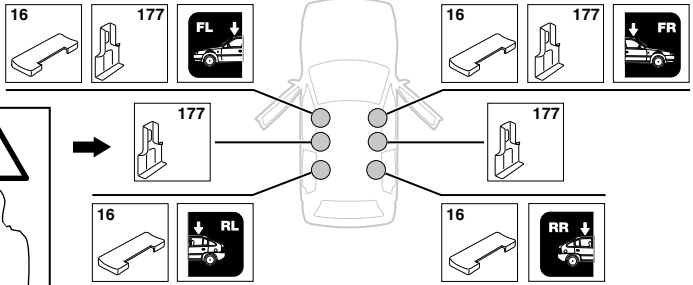
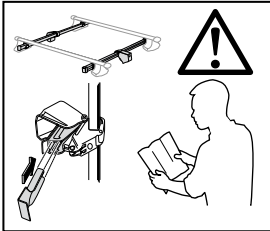

4

NISSAN Mistral, 5-dr SUV, 93-06

NISSAN Terrano II, 5-dr SUV, 93-02, 03-

FORD Maverick, 5-dr SUV, 93-99

KIA Sportage, 5-dr SUV, 94-03, 04- / *95-02

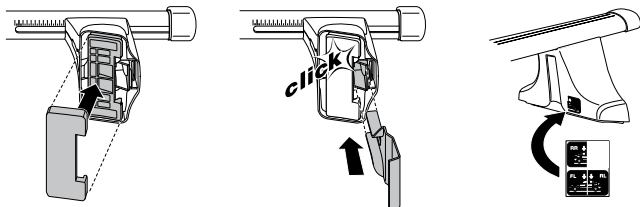
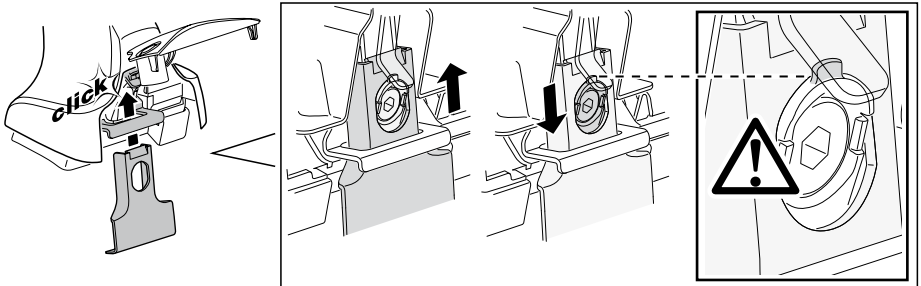
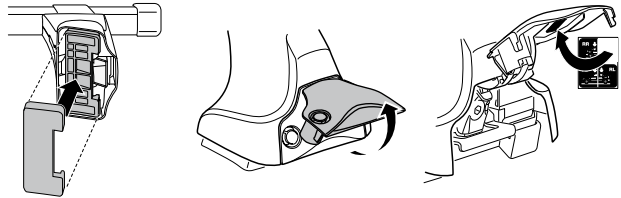
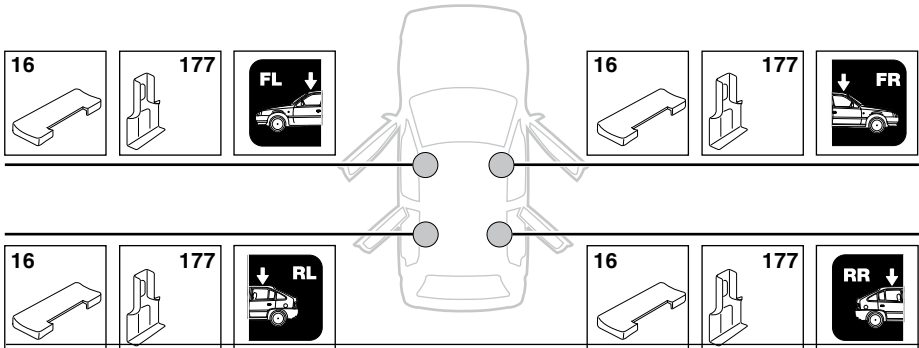

5

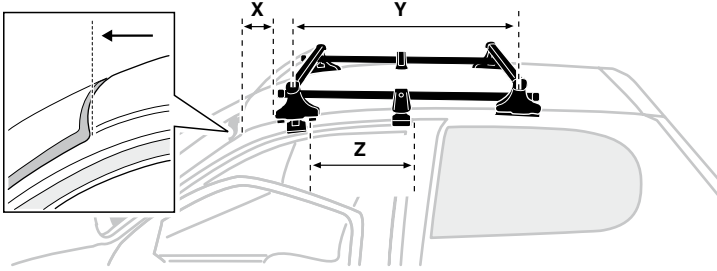
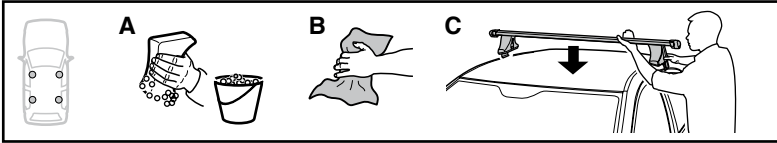

	X mm	Y mm	Z mm	X inch	Y inch	Z inch
NISSAN Mistral , 3-dr SUV, 93-06	180 mm	700 mm	290 mm	7 1/8"	27 1/2"	11 3/8"
NISSAN Terrano II , 3-dr SUV, 93-02, 03-	180 mm	700 mm	290 mm	7 1/8"	27 1/2"	11 3/8"
FORD Maverick , 3-dr SUV, 93-99	180 mm	700 mm	290 mm	7 1/8"	27 1/2"	11 3/8"
KIA Sportage , 3-dr SUV, 96-03 / *96-02	220 mm	700 mm	330 mm	8 5/8"	27 1/2"	13"

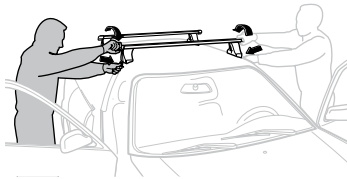
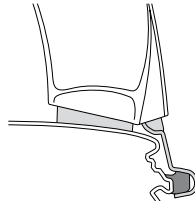

GB/US Tighten alternately

D Die Schrauben abwechselnd anziehen

F Serrer alternativement chaque côté

NL Afwisselend aan de linker- en de rechterkant aandraaien

I Alternare il serraggio delle viti

E Serrare alternativamente

PT Aperte alternadamente

S Dra åt växelvis

FIN Kierrä vuorotellen

EST Pinguldage vaheldumisi

LAT Pievelciet pamišus

LIT Užsukinėkite pakaitomis

PL Śruby dokręcaj naprzemiennie

RU Затягивайте попеременно

CZ Pokręťta bāgažnika dokręcaj dokręcaj naprzemiennie.

SK Doťahujte striedavo

SLO Privijajte izmenično.

HR Naizmjenično zategnite

HU Egymástól függetlenül szorítandó

GR Σφίγγετε εναλλάξ

TR Dönüşümlü sıkın

中文 交替拧紧

한국어 번갈아 가며 조이십시오.

日本語 交互に締め付けてください。

ไทย ชับในแบบสลับ

5

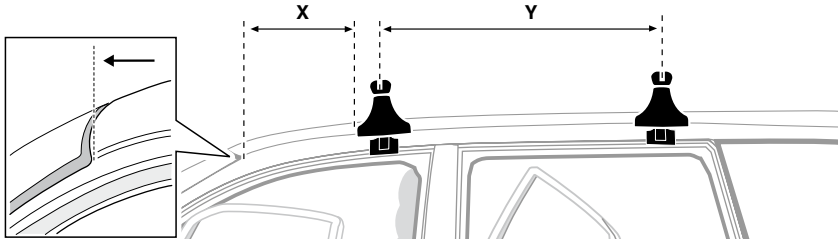
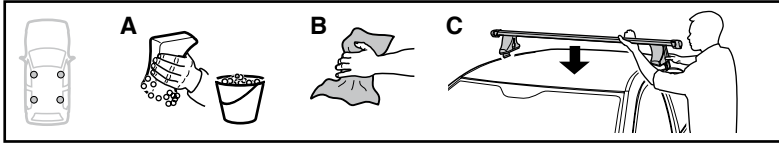

	X mm	Y mm	X inch	Y inch
NISSAN Mistral , 5-dr SUV, 93-06	180 mm	700 mm	7 1/8"	27 1/2"
NISSAN Terrano II , 5-dr SUV, 93-02, 03-	180 mm	700 mm	7 1/8"	27 1/2"
FORD Maverick , 5-dr SUV, 93-99	180 mm	700 mm	7 1/8"	27 1/2"
KIA Sportage , 5-dr SUV, 94-03, 04- / *95-02	270 mm	700 mm	10 5/8"	27 1/2"

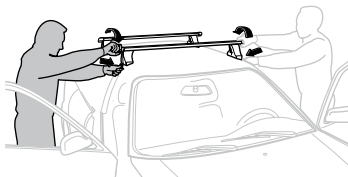
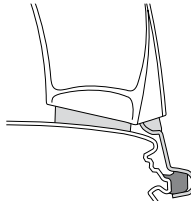

GB/US Tighten alternately

D Die Schrauben abwechselnd anziehen

F Serrer alternativement chaque côté

NL Afwisselend aan de linker- en de rechterkant aandraaien

I Alternare il serraggio delle viti

E Serrare alternativamente

PT Aperte alternadamente

S Dra åt växelvis

- FIN** Kierrä vuorotellen
EST Pinguldage vaheldumisi
LAT Pielieciet pamišus
LIT Užsukinėkite pakaitomis
PL Śruby dokręcaj naprzemiennie
RU Затягивайте попеременно
CZ Pokręťta багаžníka dokręcaj dokręcaj naprzemiennie.
SK Doťahujte striedavo
SLO Privijajte izmenično.
HR Naizmjenično zategnite
HU Egymástól függetlenül szorítandó
GR Σφίγγετε εναλλάξ
TR Dönüşümlü sıkın
中文 交替拧紧
한국어 번갈아 가며 조이십시오.
日本語 交互に締め付けてください。
ไทย ขันในแบบสลับ

6



480R/754



480

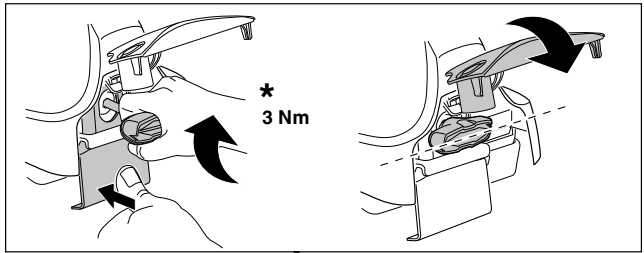
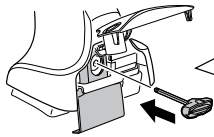

*
3 Nm

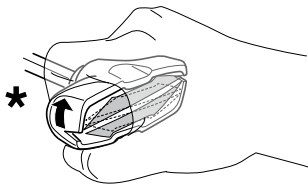

*

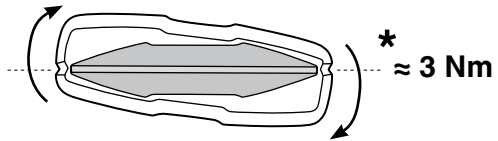

*
≈ 3 Nm

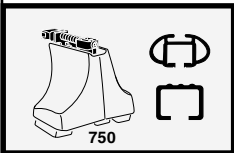
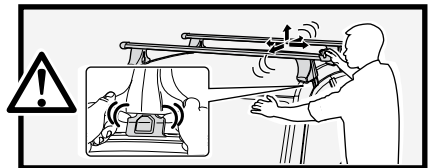

750

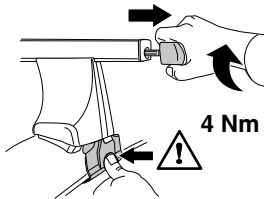

4 Nm

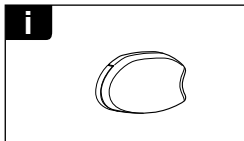
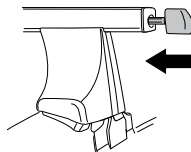

i

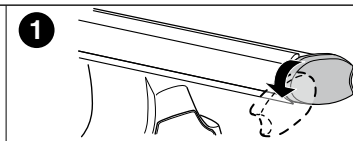

1

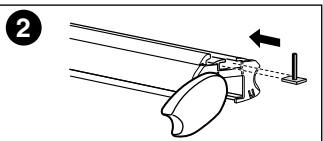

2

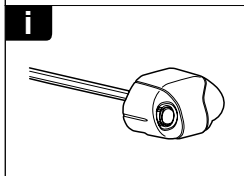

i

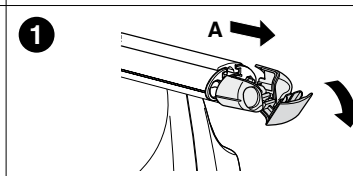

1

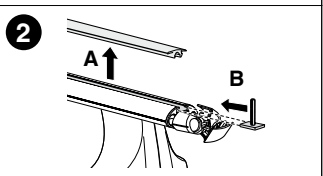

2

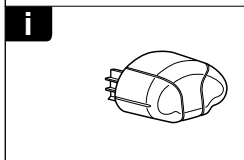

i

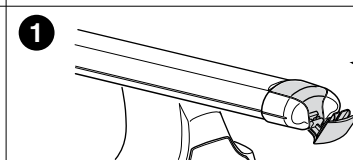

1

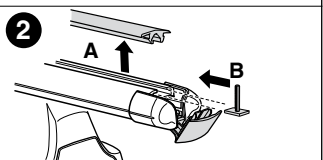

2

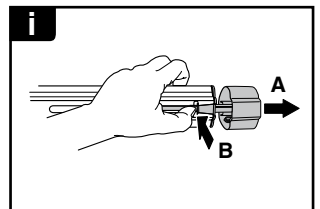
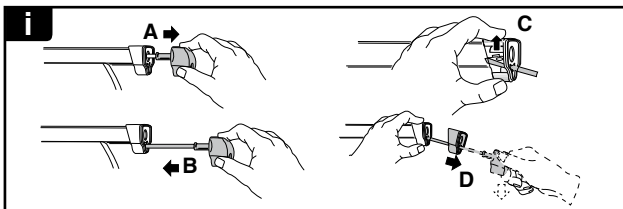
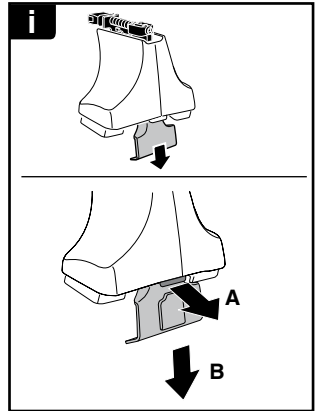
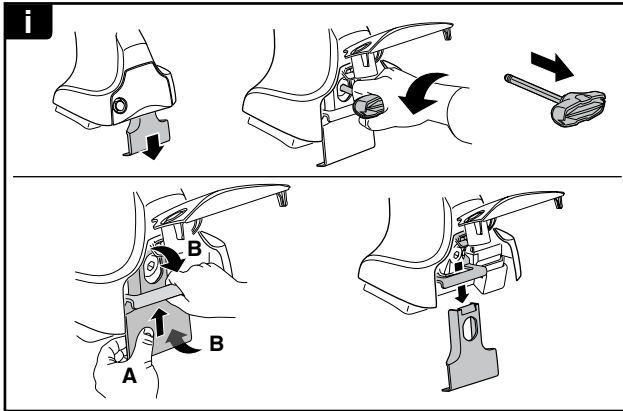
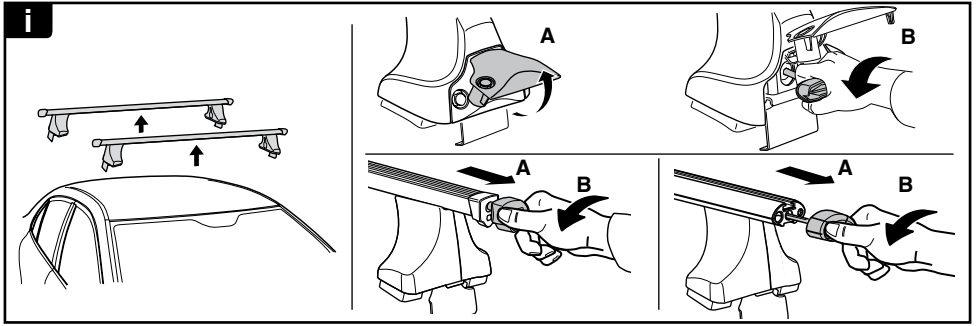

THULE
SWEDEN
**ONE
KEY
SYSTEM**

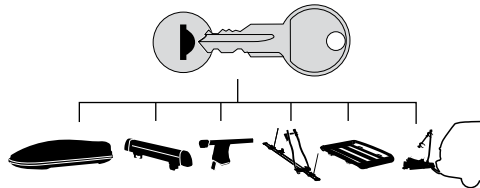

- 544 (x4)
- 596 (x6)
- 588 (x8)
- NA 510 (x10)
- EUR 452 (x12)
- ASIA

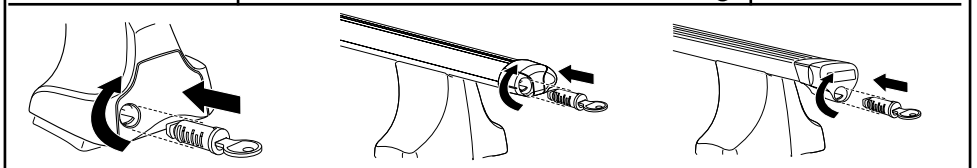

WW ▶ Thule Sweden AB, Box 69, 330 33 Hillerstorp, SWEDEN
 NA ▶ Thule Inc., 42 Silvermine Road, Seymour, Connecticut 06483, USA

info@thule.com
 customer.service@thule.com

www.thule.com